

126.2

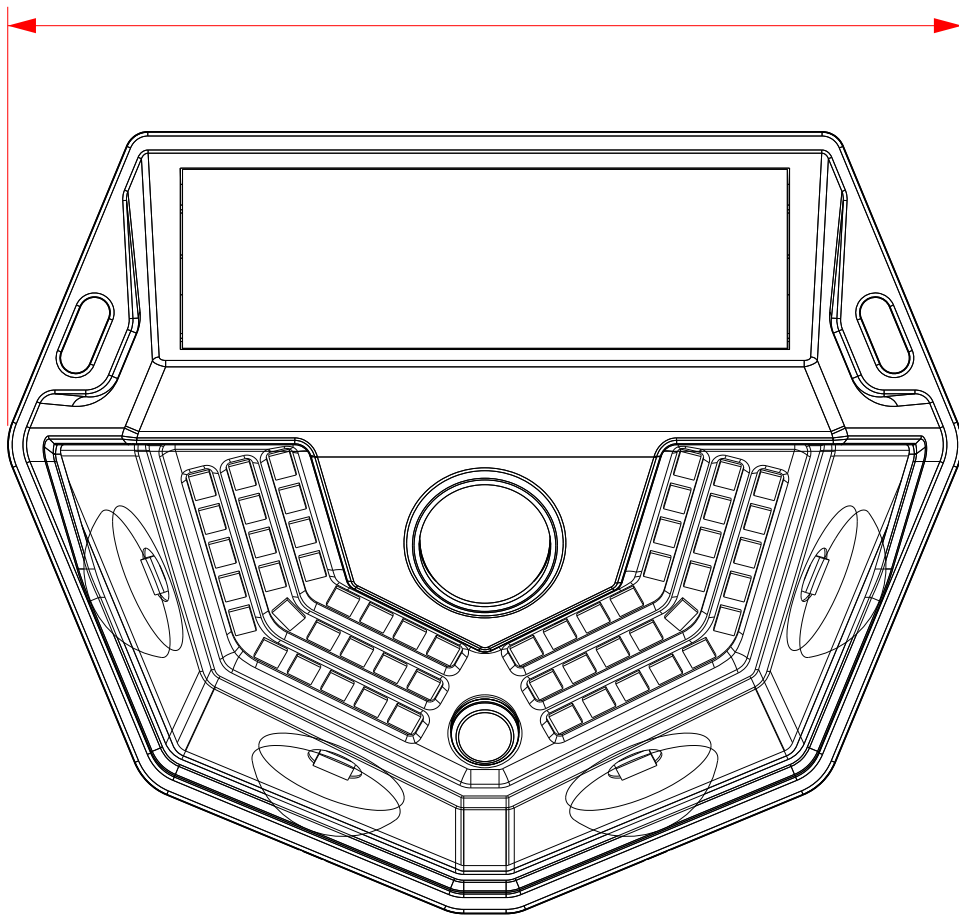

51.2

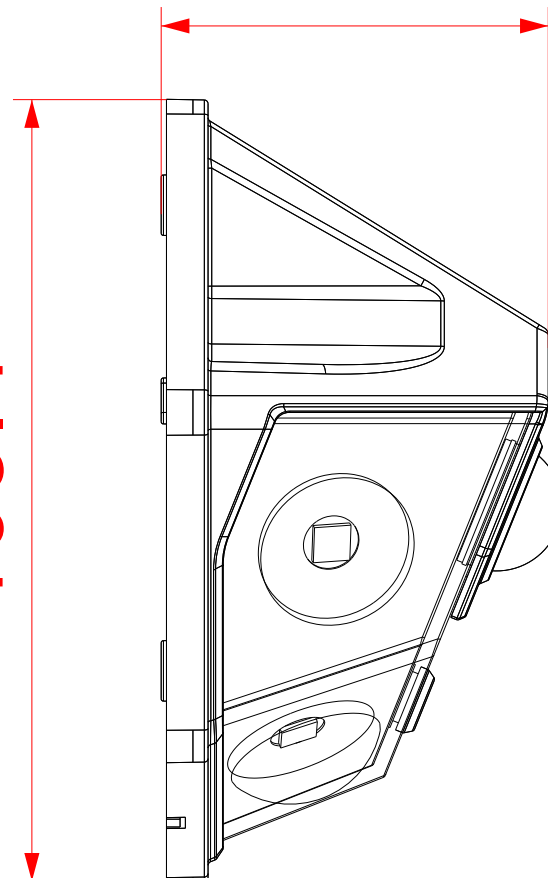

103.4

