

ZHUI LIANG

LED STREET LIGHT

ZhuiLiang Series

2022

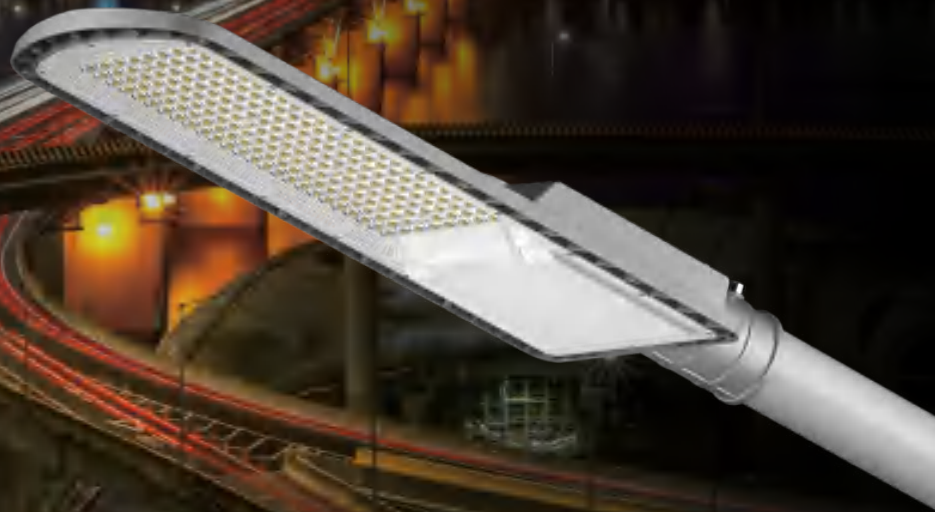

ZHONGSHAN YUANZHI LIGHTING CO., LTD.

OVERVIEW

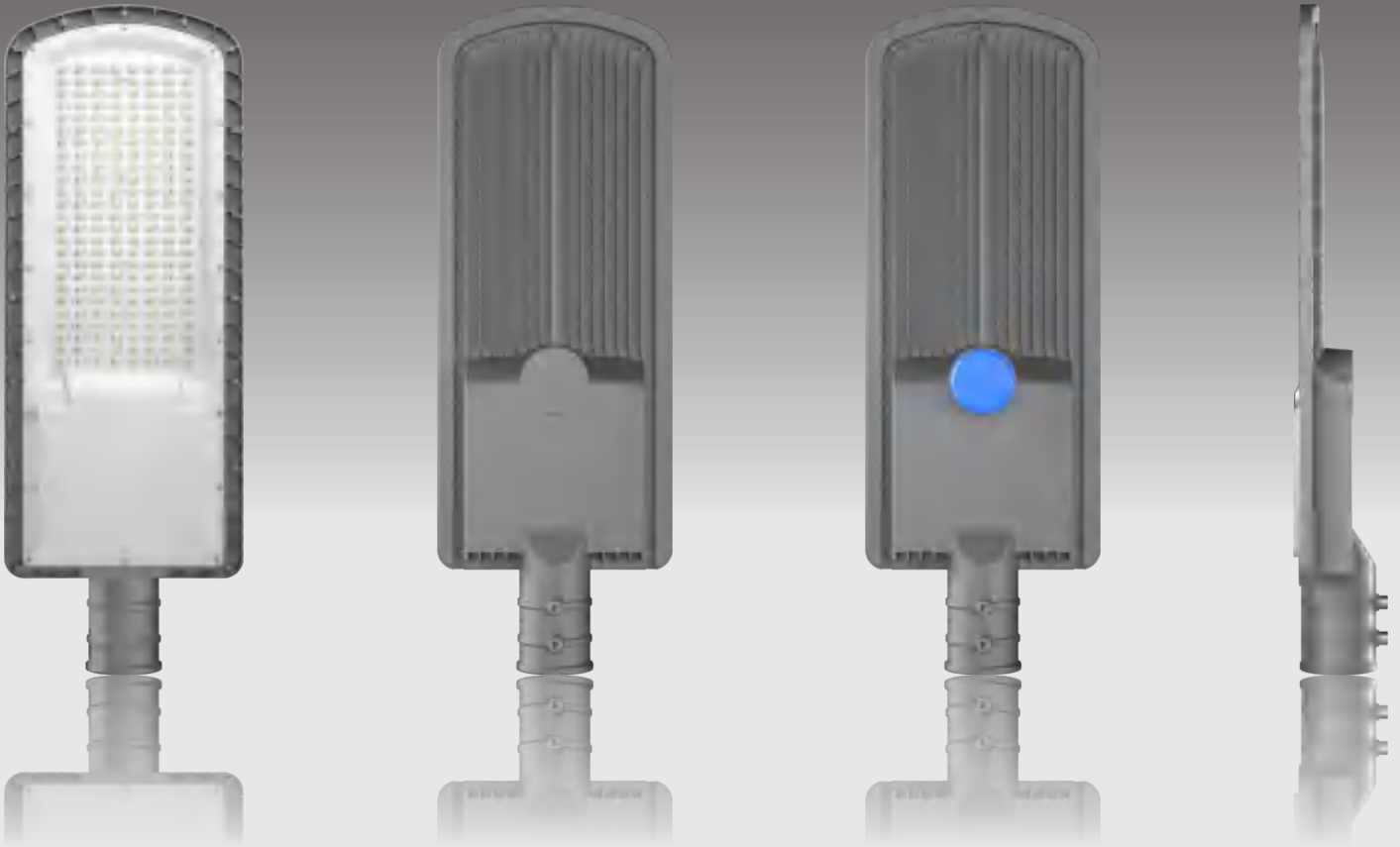

Thermal Management

Structure is optimized by advanced FEA technology. Well managed temperature rise between internal and external parts. Even thermal distributions. Higher lumen maintenance rate.

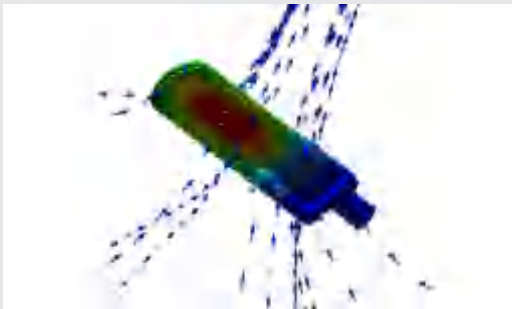

Thermal Air Convection

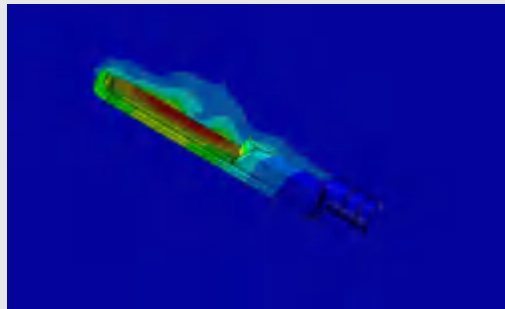

Thermal Effects to Air

Unit: °C

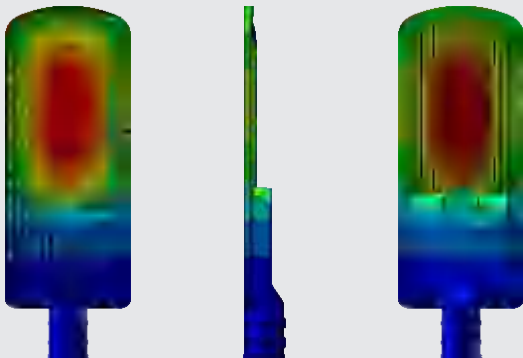

Thermal Conductivity

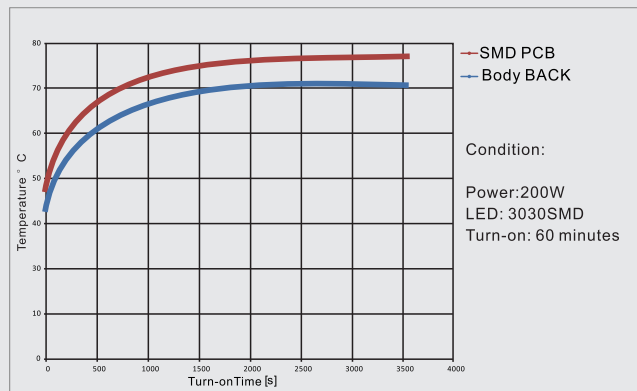

Temperature Rise

EXPLODED

ADC12 die-casting aluminum body,
thermal efficiency up to 96W/M.K.

Optional with sensor

Highly thermal conductive aluminum pcb

Famous Brand Waterproof LED Driver

3030SMD light source, lighting
efficacy up to 150lm/W

UV-proof waterproof silicone gel

UV-proof optical lens.
Precision road lighting distributions.

Streamline design, wind-proof.

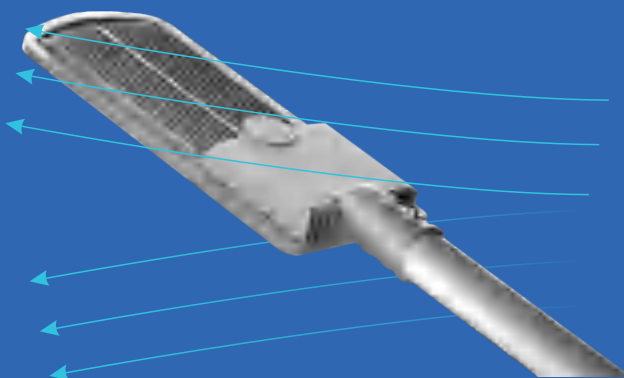

Reliable wind-proof structure

APPLICATIONS

Widely applicable to road, expressways, parks, plazas and villas.



OPTICS

Tech. Support: Tell us the room length, width, height and the usage. We have an engineer team to respond the DIALUX simulations for lights quantity calculation and effects. . ies files are available upon request.

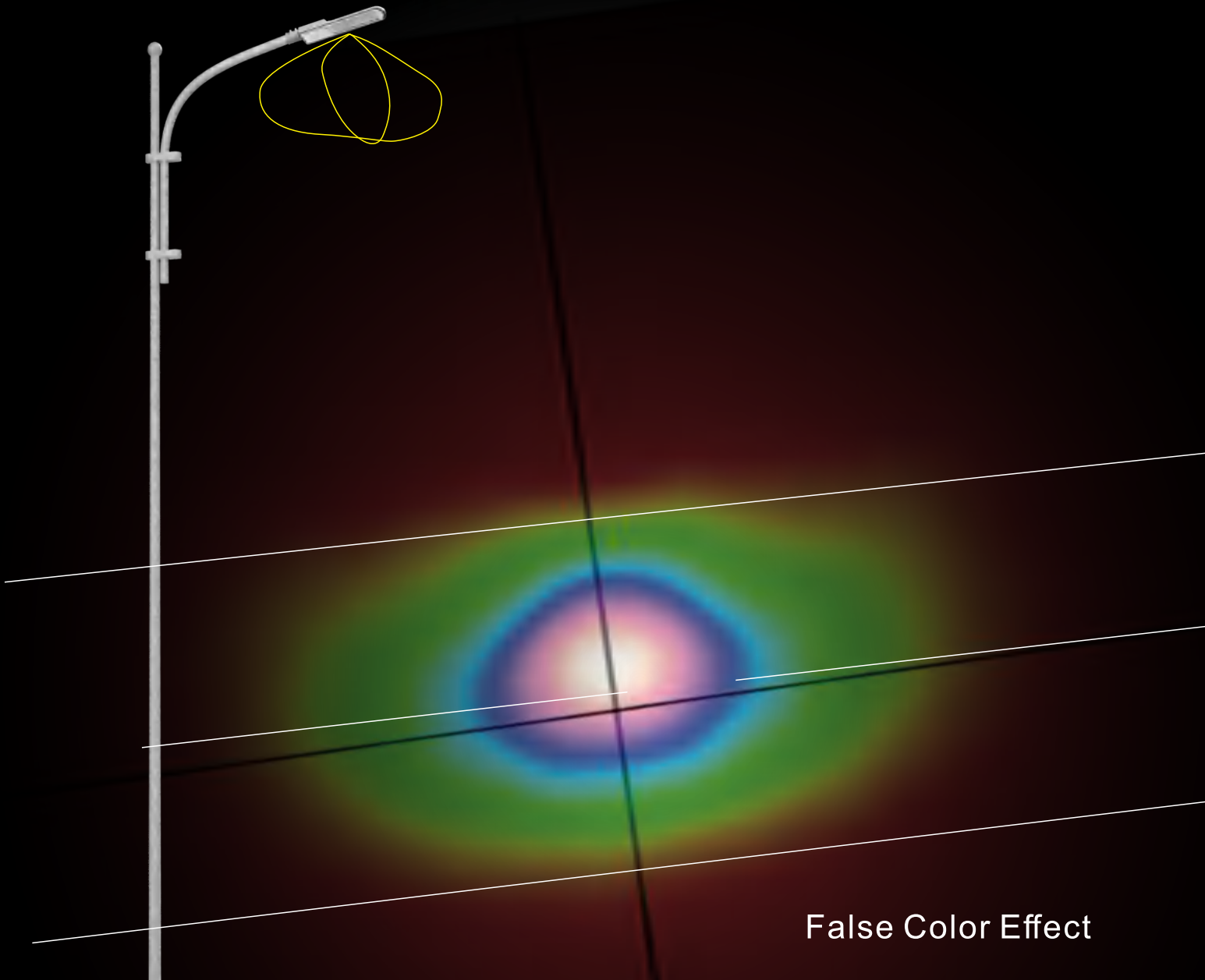
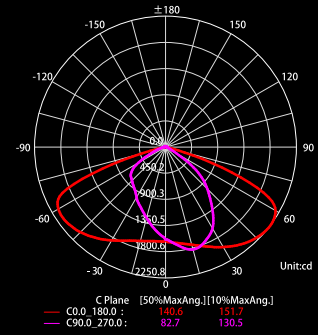
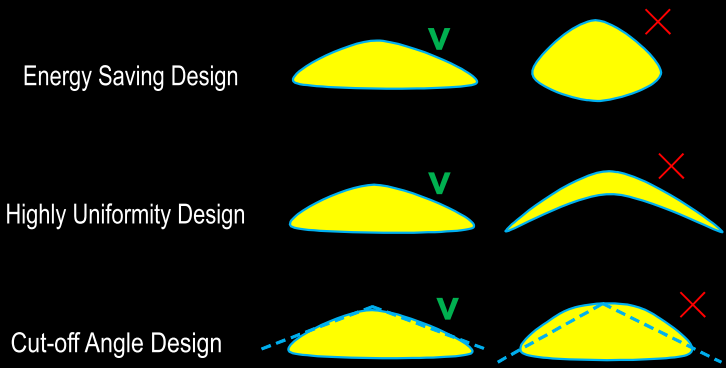

DIAGRAMS

Unit:mm

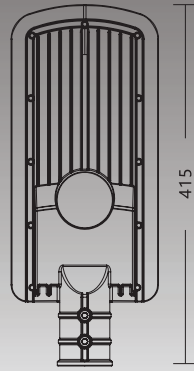
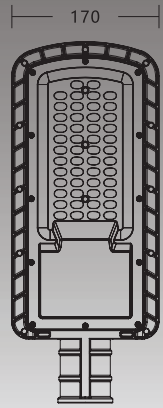

50W

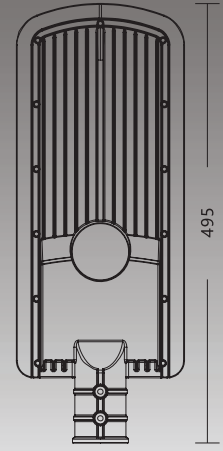
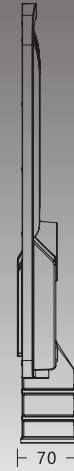
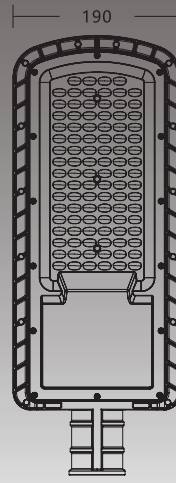

100W

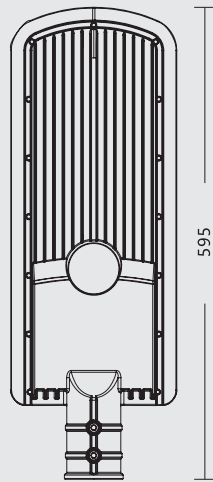
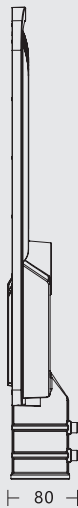
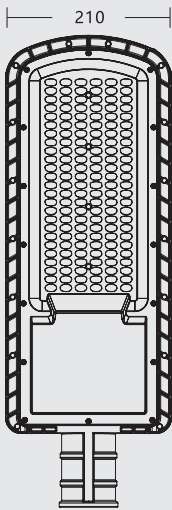

150W

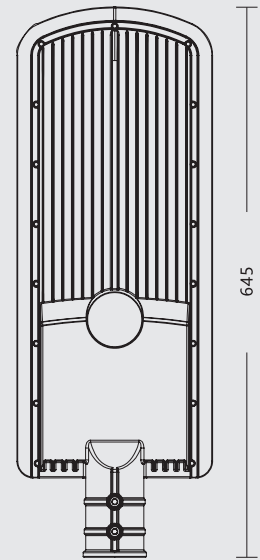
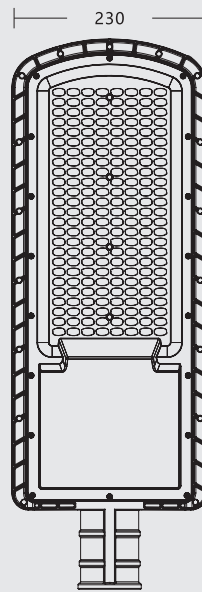

200W

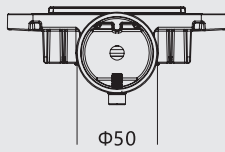

50W/100W

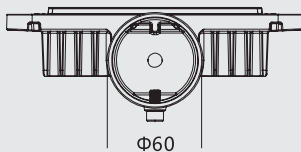

150W/200W

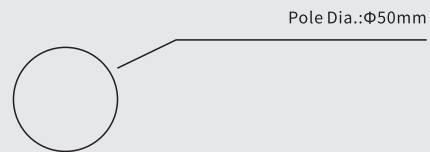

Pole Dia.:Φ50mm

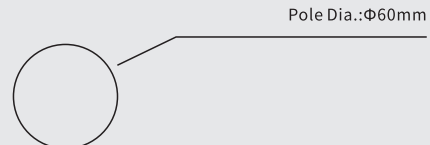

Pole Dia.:Φ60mm

MAIN PARAMETERS

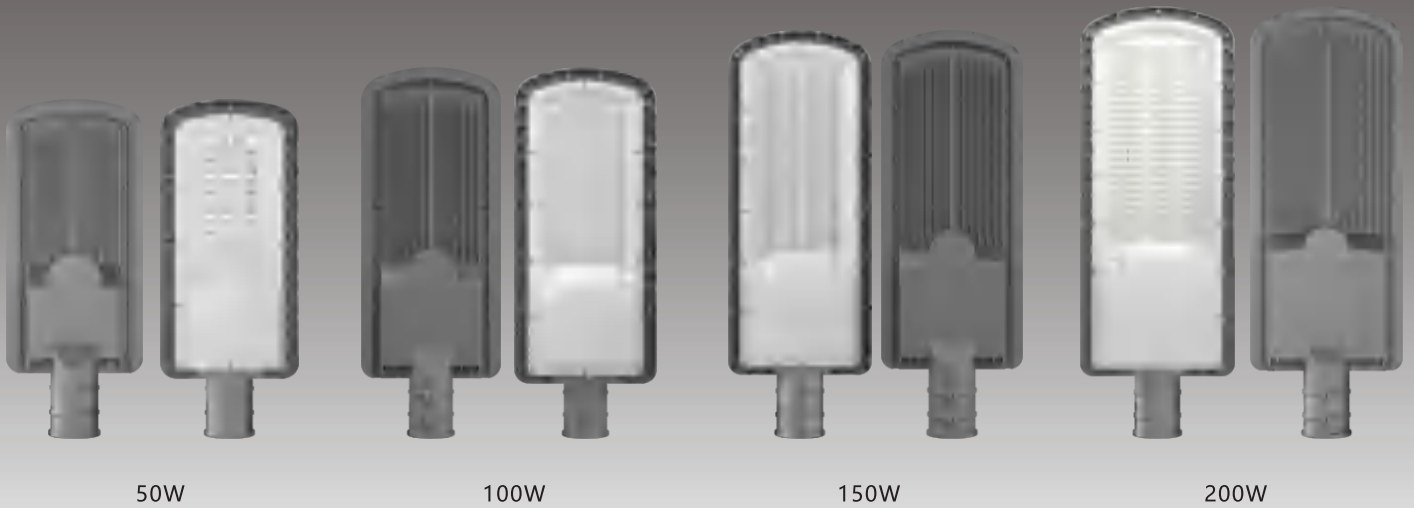

Power	Light Source	Body Size	Battery House Size
50W	3030/10B5C 3030/2B25C	415*170*70mm	105*90*45mm
100W	3030/10B5C*2 3030/4B25C	495*190*70mm	125*90*45mm
150W	3030/10B5C*3 3030/6B25C	595*210*80mm	140*120*50mm
200W	3030/10B5C*4 3030/8B25C	645*230*80mm	160*150*50mm

Packing Information

Power	CTN Size	Qty/CTN	20` GP	40` GP	40HQ
50W	405*365*440mm	10PCS/CTN	4,305PCS	8,917CS	10,455PCS
100W	405*405*520mm	10PCS/CTN	3,283PCS	6,800PCS	7,973PCS
150W	470*225*620mm	5PCS/CTN	21,35PCS	4,423PCS	5,186PCS
200W	470*245*670mm	5PCS/CTN	1,815PCS	3,759PCS	4,407PCS

Packaging

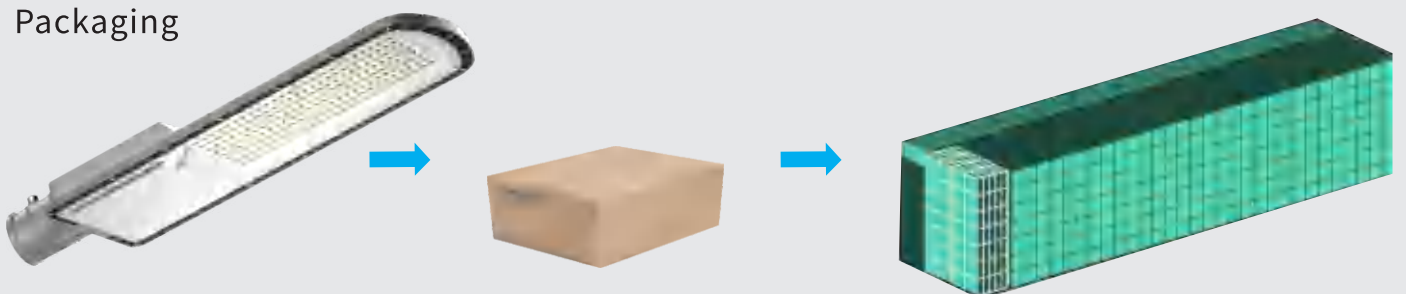

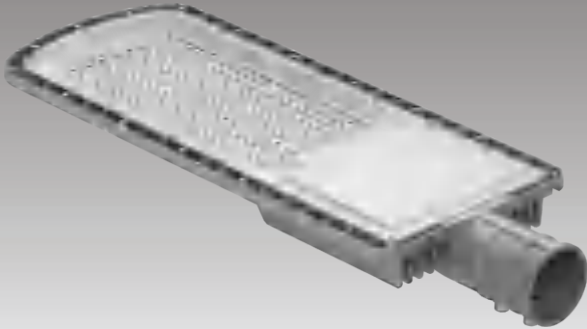

FEATURES:

1. AC85-265V 50/60Hz universal voltage.
2. Light Efficacy up to 150lm/W.
3. High lumen 3030SMD light source , LM-80 Reports and .ies files are ready.
4. Diecasting aluminum body, anti-corrosion painting.
5. IP66 waterproof for outdoor use.

CAUTIONS:

1. Installation must be done by professional electricians. .
2. Do NOT take apart the product. It may be dangerous.
3. Do NOT stare at the light with naked eyes. It is harmful to eyes.
4. For outdoor lighting, waterproof measurements must be done to the cable terminals.

WARRANTY:

1. All LED street lights are warranted by the manufacturer to be free of defects in material and workmanship for 3 years.
2. Warranty becomes void if the products is modified, improperly installed or used, damaged by accident or neglect, or if any parts are improperly installed or replaced by the user,
3. During the period of warranty time, if some products of us fails during normal circumstances and applications or have any defects above defined, we shall at our own choice replace or repair the defective products at no charge. And the liability claims would NOT exceed the value of the product itself.

